

# Liquid Freezer III 360 A-RGB

Multikompatibler All-in-One CPU-Wasserkühler mit A-RGB



## Allgemeine Spezifikationen

Kompatibilität	Intel® LGA1851, LGA1700   AMD® AM5, AM4
PI   NNPI	338   309
Wärmeleitpaste	MX-6 (0,8g)
Garantie	6 Jahre
Betriebsumgebungstemperatur	0-40°C
Gewicht	1870g
LED-Anschluss	3-Pin-A-RGB-Buchse

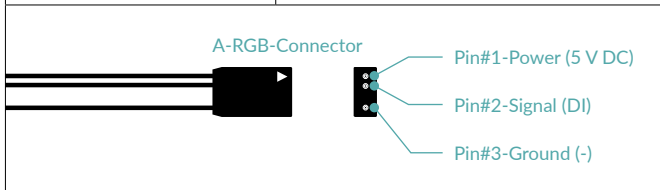

All-In-One-Anschluss	4-Pin-PWM-Buchse
----------------------	------------------

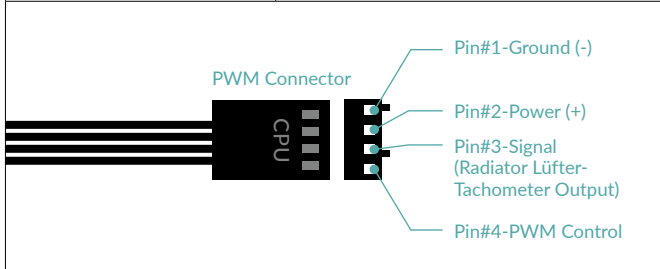

Geteilter Anschluss	3x 4-Pin-PWM-Buchse
---------------------	---------------------

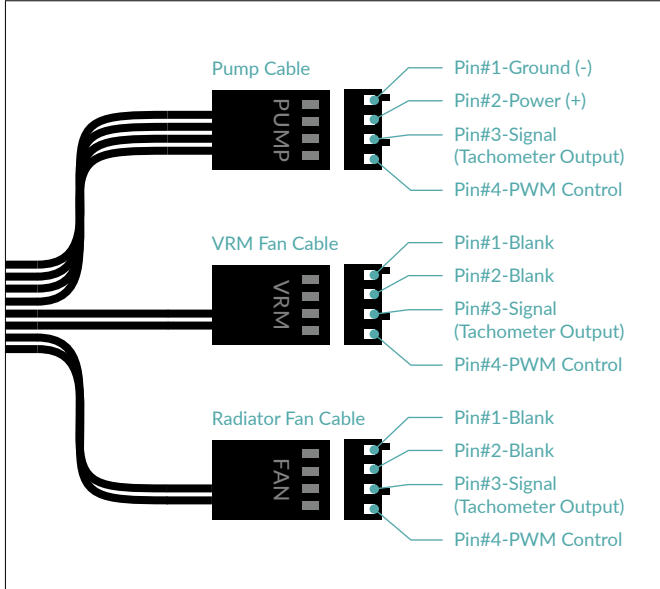

Pumpe	800-2800rpm (PWM-gesteuert)
Strom   Spannung	0,35A   12VDC
Cold Plate	Kupfer, Micro-Skived-Fins
Schlauchlänge	450mm
Schlauchdurchmesser	Äußerer: 12,4mm   Innerer: 6,0mm
<b>Radiator</b>	
Material	Aluminium
Abmessungen	398 (L) x 120 (B) x 38 (H) mm
<b>VRM-Modul</b>	
VRM-Lüfter	400-2500rpm (PWM-gesteuert)
Strom   Spannung	0,05A   12VDC
LEDs	12x A-RGB LEDs
Strom   Spannung	0,40A   5VDC

## Radiatorlüfter-Spezifikationen

Allgemein	3x P12 PWM A-RGB
Geschwindigkeit	200-2000rpm
Luftstrom	48.82 cfm   82.91 m³/h
Statischer Druck	1,85 mmH <sub>2</sub> O
Lager	Hydrodynamisches Gleitlager
Strom   Spannung	0,11A   12VDC
Kabellänge	40mm
Anschluss	4-Pin-PWM-Buchse
<b>RGB-Spezifikationen</b>	
LEDs	12x A-RGB LEDs
Strom   Spannung	0,40A   5VDC
Kabellänge	40mm + 80mm Splitter-Kabel
Anschluss	3-Pin-A-RGB-Buchse + 3-Pin-Stecker

## Versandinformationen - LF III 360 A-RGB (Black)

Box Abmessungen	414 (L) x 167 (B) x 142 (H) mm
Brutto Gewicht	2430g
SKU	ACFRE00144A
EAN	4895213704526
UPC	840033402293

## Versandinformationen - LF III 360 A-RGB (White)

Box Abmessungen	414 (L) x 167 (B) x 142 (H) mm
Brutto Gewicht	2430g
SKU	ACFRE00152A
EAN	4895213704564
UPC	840033402330

# Liquid Freezer III 360 A-RGB

Multikompatibler All-in-One CPU-Wasserkühler mit A-RGB

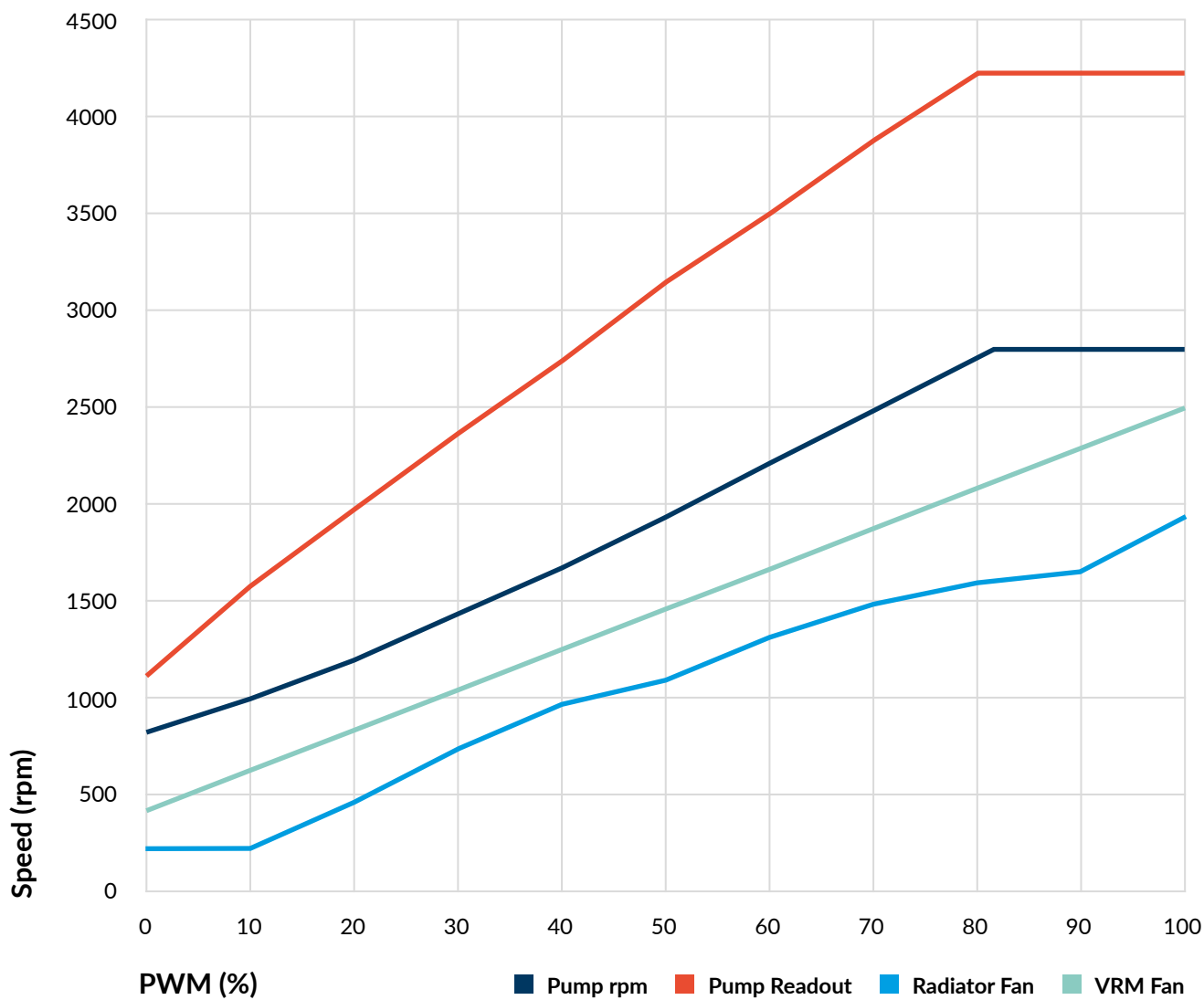

# Liquid Freezer III 360 A-RGB

Multikompatibler All-in-One CPU-Wasserkühler mit A-RGB

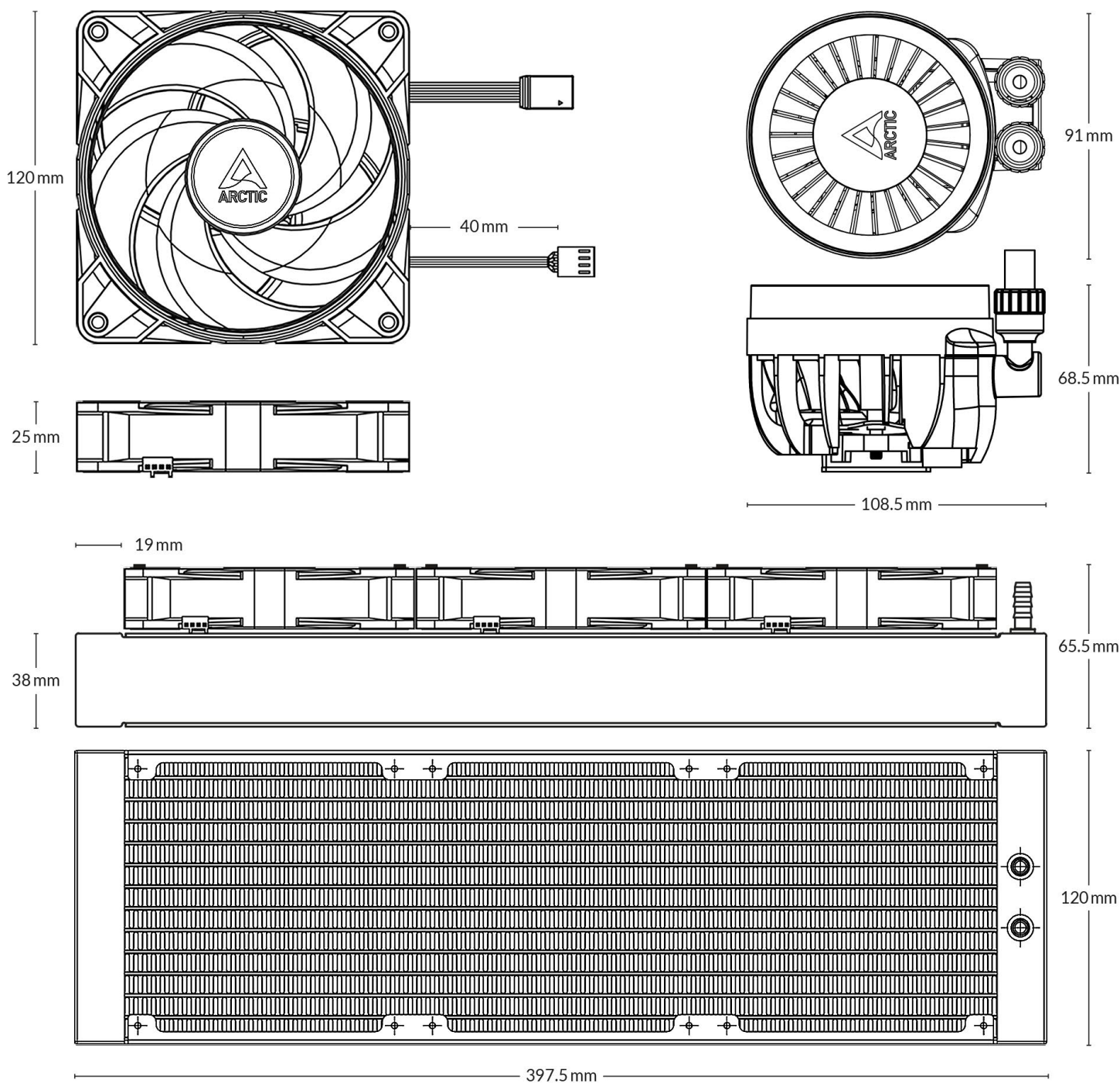

Alle Materialien sind mit den RoHS-Anforderungen kompatibel.

WEITERE INFORMATIONEN



ANLEITUNGEN

